

Index

Site Survey	Pg 3
Multiple Handset Wiring Survey	Pg 3
Opening the Outdoor Station	Pg 4
Wiring	Pg 4
Mounting Handsets	Pg 5
Connecting to Gates and Locks	Pg 5
Power at Gate	Pg 6
Keypad Overview	Pg 6
Keypad Quick Start	Pg 7
Keypad Full Programming	Pg 7
Using a Standard Keypad Code	Pg 8
Using a Latching Code	Pg 8
How to Use the Intercom	Pg 9
Troubleshooting	Pg 11
Change History	Pg 12

Site Survey

Before installing this system, please check the cable type which exists and then design the installation accordingly.

The maximum distance between the outdoor and indoor units depends on the type and thickness of cable used, the number of handsets on the system and if the handsfree or classic handsets are being used (handsfree use double the power).

Method 1 Wiring with Single PSU (Short distance)

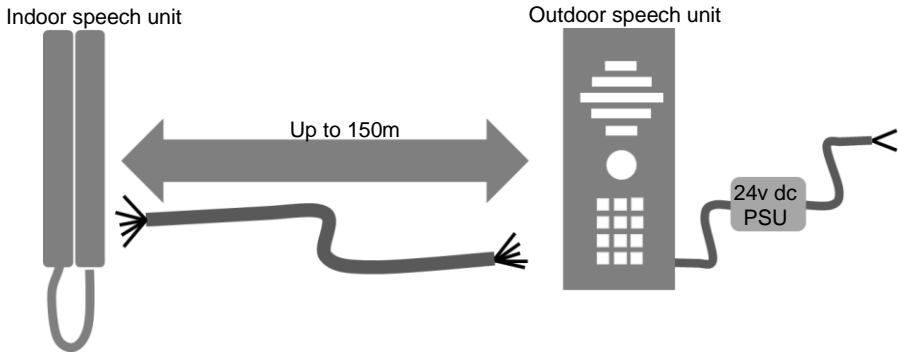

Method 2 Wiring with dual PSU's (Longer distance)

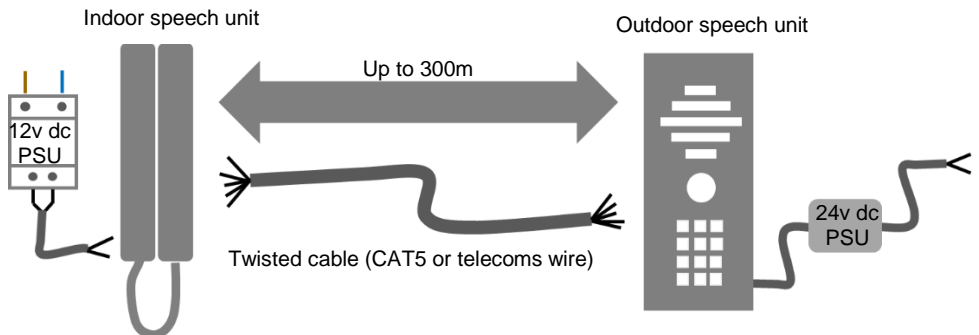

Multiple Handsets Wiring Method (Recommend Dual PSU method)

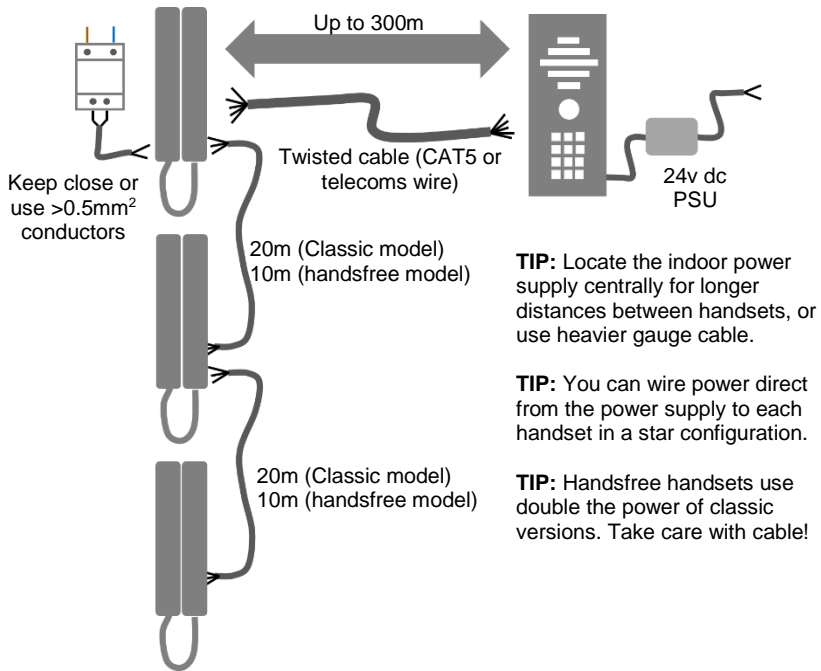

Opening the Outdoor Station

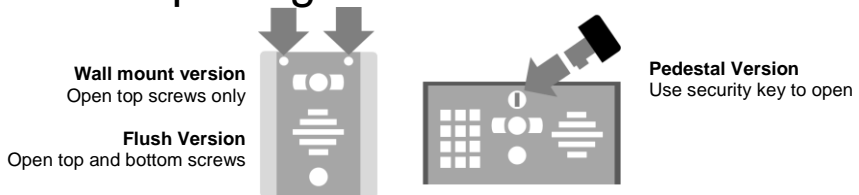

Wiring Method 1 (Single PSU) Up to 150m

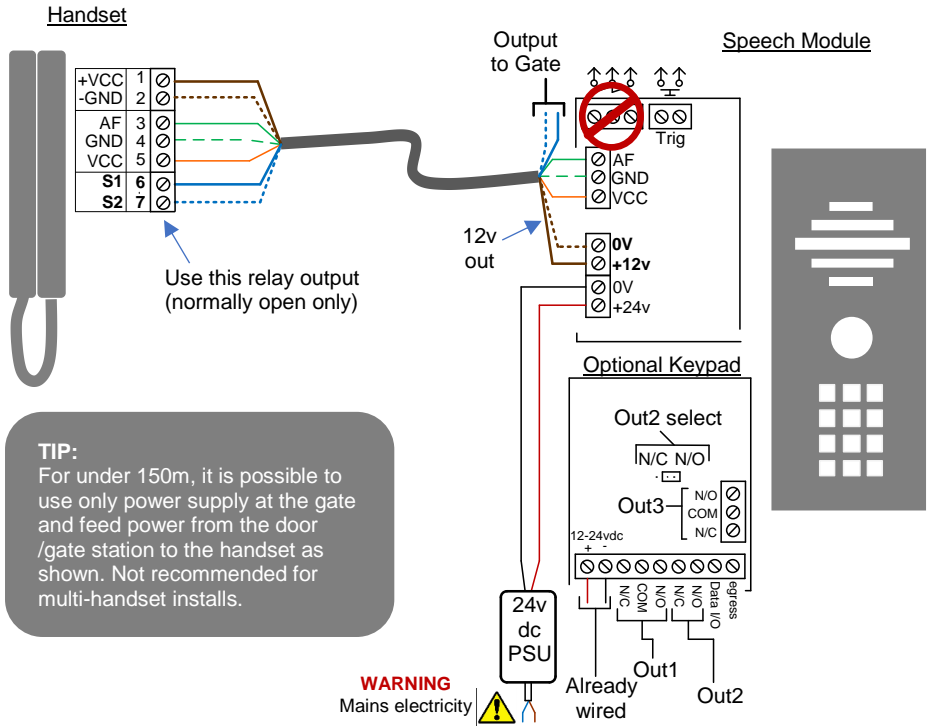

TIP:
For under 150m, it is possible to use only power supply at the gate and feed power from the door/gate station to the handset as shown. Not recommended for multi-handset installs.

TIP:
Keypad has independent relays from the speech module. Both need connected!!
Connect in parallel for gate automation or strike locks, and in series for magnetic lock control.

Mounting Handsets

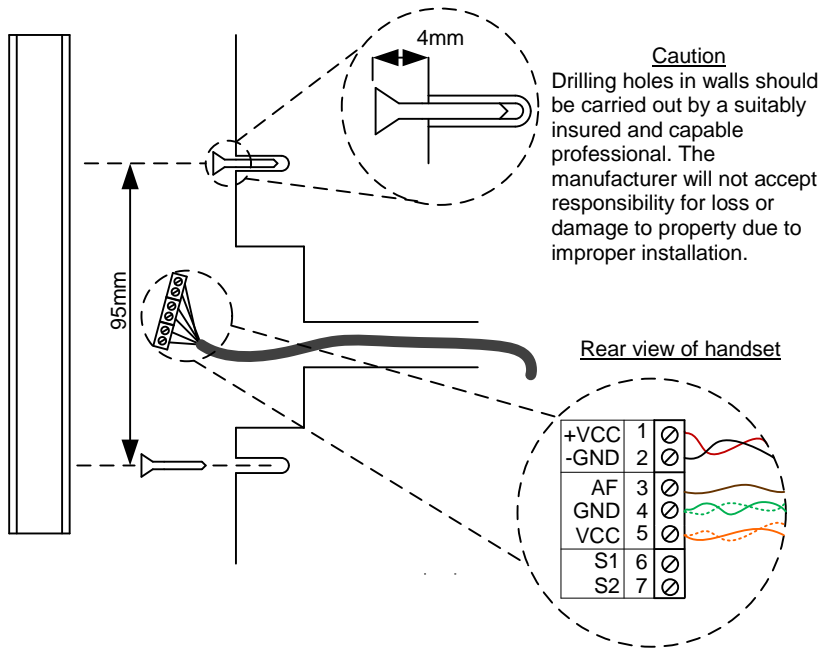

Connecting Relays to Gates & Locks

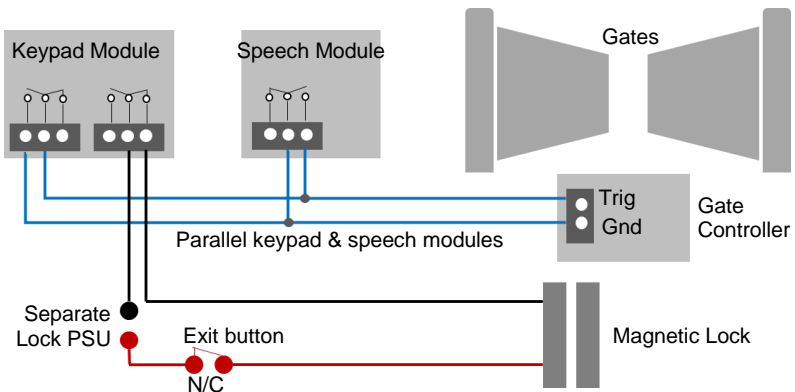

Power at Gate

This intercom comes with a 24v dc power supply for the outdoor speech unit. Relays can require up to 1 amp peak demand to trigger, therefore power cable is of significant importance. It is preferred the 24v dc PSU is installed within close proximity of the intercom. However, on occasion this may be difficult to achieve. Please adhere to the cable thickness guide below or the device may be damaged and rendered out of warranty by the manufacturer.

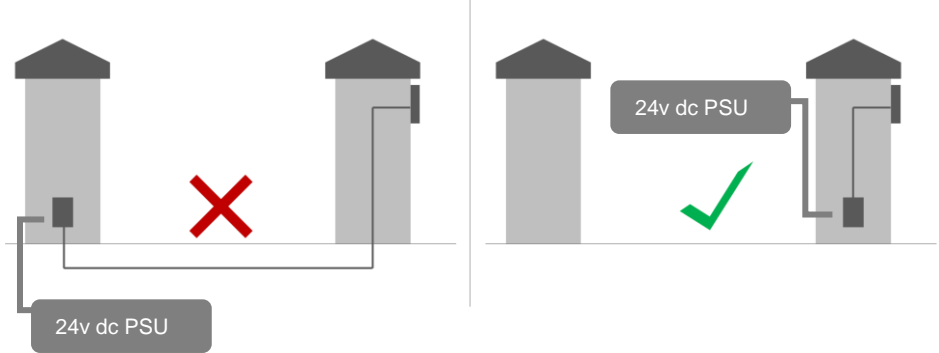

- Up to 2 meters (6 feet) use minimum 0.5mm.
- Up to 4 meters (12 feet) use minimum 0.75mm.
- Up to 8 meters (25 feet) use minimum 1.0mm.

Keypad overview

This keypad has 3 outputs, all independent from the intercom/app relays. The diagram below shows the LED indicators which indicate programming and relay status information.

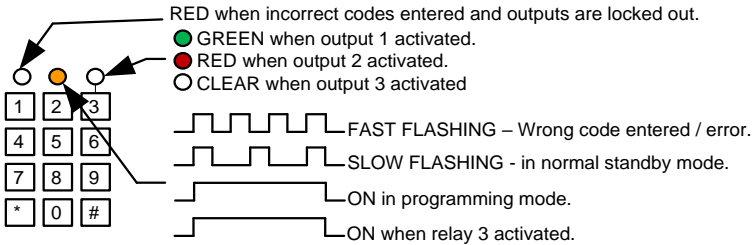

TIP: After power up, as a security precaution, the keypad cannot be programmed for 60 seconds. Once this time elapses, you may begin.

TIP: Flashing amber LED is normal standby mode!

Programming relay output times and modes...

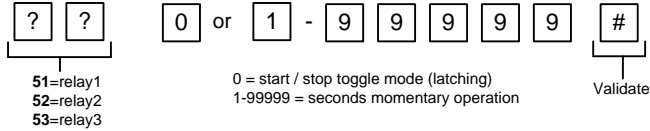

Delete a user code even if you don't know the code...

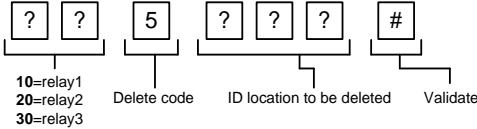

Delete an entire group of codes

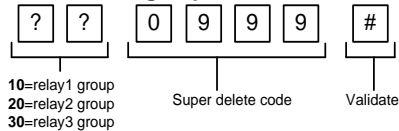

Programming super user codes...

A super user code can activate any of the 3 relays

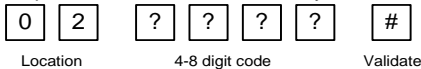

Restoring defaults

When in programming mode, you can enter the following sequence...

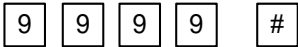

When the engineers/installers code is forgotten....

- 1) Wire a push button (or replicate with wire link) across the Egress terminal and (-)GND.
- 2) Switch off power for 1 minute.
- 3) Switch ON power.
- 4) during the first 60 seconds, press the EG button once to enable the function.
- 5) Enter the following code..

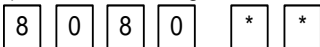

The keypad should now be in programming mode, ready to accept new data. Change the installers/engineers code now as per instructions above.

Using a Standard Keypad Code

Simply enter the code to trigger the gate or release the door.

Using a Latching Code

Enter the latching code on automatic gates to hold them open. Note: the code will need entered again to unlatch the gates.

How to Use the Intercom

SLIMCLASSIC

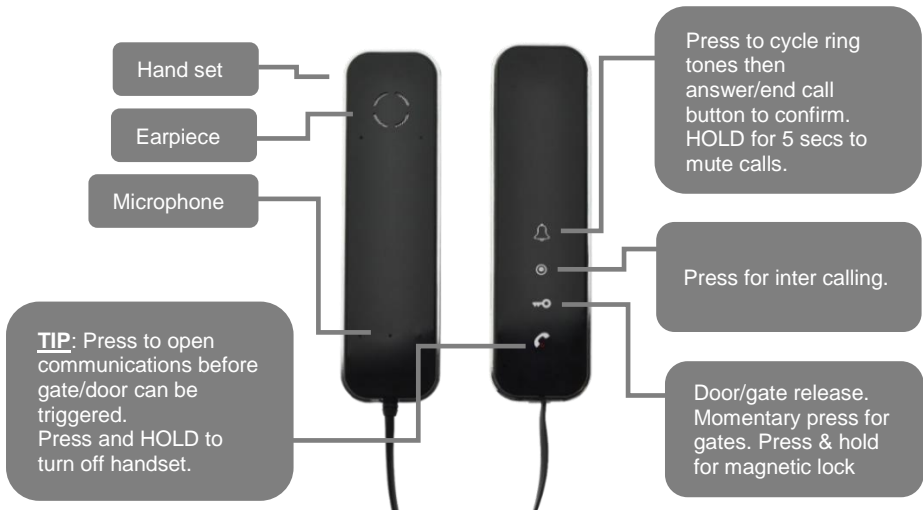

SLIMHANDSFREE

